

MPRT

Megger Protective Relay Test System



Shown without optional adjustable carry handle.

- The MPRT System consists of a 'Power Box', the TouchView Interface™, and AVTS Software
- Unique new TouchView Interface (TVI) simplifies the manual testing of complex relays
- Ultra flexible output design provides up to four-phase voltage and current or eight-phase current
- User specified configuration. Every system is made to order based on specific customer needs.
- Includes fully automated testing capability using AVTS Software (Version 3.1)

DESCRIPTION

The MPRT System is comprised of:

- The 'Power Box'
- The TouchView Interface (TVI)
- AVTS Software

The 'Power Box' is the heart of the system. It employs a variety of new features including unique Voltage and Current Generator (VI-Gen) components which have been combined into one amplifier package. Using multiple VI-Gens provides the flexibility to deliver four voltages (or two three-phase open delta voltages) and four currents or combinations up to eight current channel capability. The MPRT 'Power Box' also incorporates three communication ports, a new Constant Power Output (CPO) capability and every one is made-to-order based on each customer's individual testing requirements.

The TouchView Interface (TVI) device and AVTS Basic Software form the brains of the system. The TVI, with its large full color touch screen allows the user to perform manual and semi-automatic testing quickly and easily, using built-in, preset test routines for most popular relays. Fully automatic testing can also be performed using AVTS Basic Software which comes with the MPRT System.

APPLICATIONS

MPRT is specifically designed to perform routine testing of protective relays used in the operation of electric utilities, power plants and heavy industrials. Other applications include use in government facilities, harbor and airport installations, large building complexes and by testing service companies who are increasingly interested in a highly flexible, easy-to-use relay test instruments that can help them improve their job efficiency.

MPRT SYSTEM COMPONENTS

The 'POWER BOX'

The 'Power Box' is ultra flexible, rugged, lightweight and feature packed. The unique features include:

NEW Constant Power Output (CPO) Capability –

Produces improved power output sustainable through the entire "power curve" of a test. With a CPO of 200 VA per current channel it has the power and flexibility to test any relay.

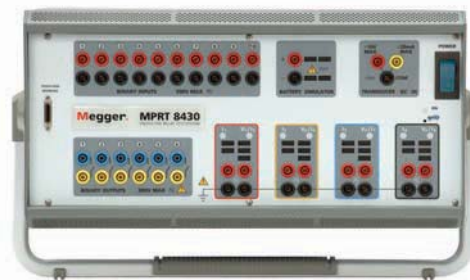

Shown with optional adjustable carry handle.

Unique VI-Gen Internal Design – The Voltage and Current Generator (VI-Gen) components have been combined into one amplifier package. Using multiple VI-Gens the system has the flexibility to deliver four voltages (or two three-phase open delta voltages) and four currents or eight currents for testing multi-phase differential relays.

Built-in Transducer Testing Capability – Eliminates the need for additional testing equipment or software. The MPRT incorporates high accuracy amplifiers, a special transducer DC input and test algorithms to test transducers easily and effectively.

Includes Three Communication Ports – More built-in flexibility with a protocol choice of IEEE488, RS232 or Ethernet for high-speed download capability and upgrades via the internet.



Back view of MPRT.

User Specified Configuration – Every system is made to order based on each customer's testing requirements and budget, with an easy and flexible upgrade path.

Output Capabilities for Worldwide Use – Even more built-in flexibility allows the user to choose from:

- VI-Gen amplifiers rated at 30A @ 200 VA and convertible amplifiers rated at 300V or 5A @ 150 VA.
- VI-Gen amplifiers rated at 15A @ 200 VA and convertible amplifiers rated at 150V or 5A @ 150 VA.

THE TOUCHVIEW INTERFACE (TVI)

Finally...an easier way to perform manual and semi-automatic relay testing. It's all done via a unique hand held controller called the TouchView Interface (TVI). The most significant feature of the TVI is its ability to provide the user with a very simple way to manually test even the most complex relays manufactured today.

Manual operation is simplified through the use of a built-in computer operating system and the TouchView Interface, with a large color LCD touch-screen. The TVI eliminates the need for a computer when testing virtually all types of relays. Menu screens and function buttons are provided to quickly and easily select the desired test function.



MPRT TouchView Interface™

Here's how easy it is

From the Preset Menu Screen, shown below, the user simply selects the type of relay to be tested. Built-in test files are for a wide variety of protective relays, including Overcurrent, Differential, etc., see following figure.

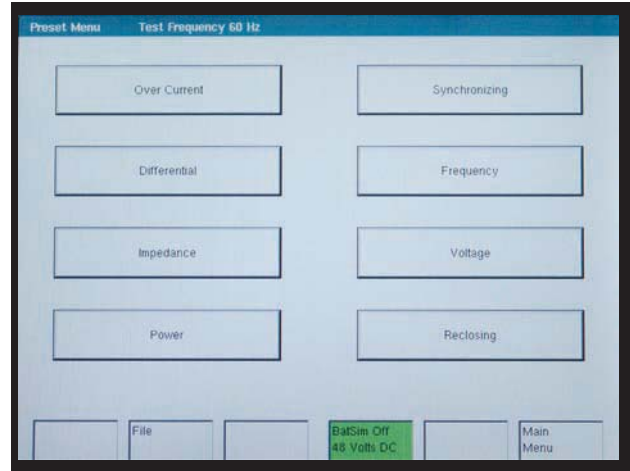

Preset Relay Menu Screen

As an example, touch the 'Over Current' button. An Overcurrent Test Menu Screen, shown below, will be displayed showing all necessary functions needed to test that particular type of relay. Next, the user inputs the relay setting values that will be used to conduct the tests, such as Relay Tap value and Time Dial value. These values are used when conducting the pickup and timing tests.

To make it even better, the TVI has both IEEE and IEC time curve algorithms built-in. By entering the appropriate values in the setting screen, when the timing test is conducted, the test results will be automatically compared to the theoretical values from the time curve that was selected.

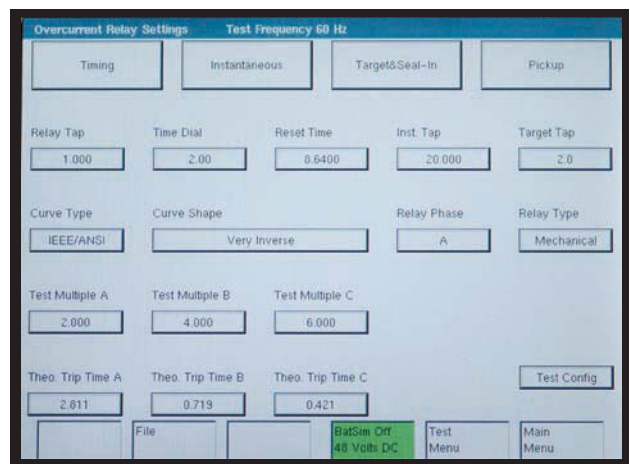

Overcurrent Relay Settings Screen

As shown in the Overcurrent Settings screen, the IEEE Very Inverse time curve was selected. If the Test Multiple is changed, the appropriate theoretical trip time will change automatically.

The TVI also has the ability to do even more complex tests and calculations. For example, the MPRT with three Voltage/Current Modules, can test single-phase, three-phase open delta, and three-phase wye impedance relays using the Impedance relay test screen. The user simply selects different testing applications from a menu screen. For instance, the Reach Test Settings Screen for an impedance relay has been selected as shown below.

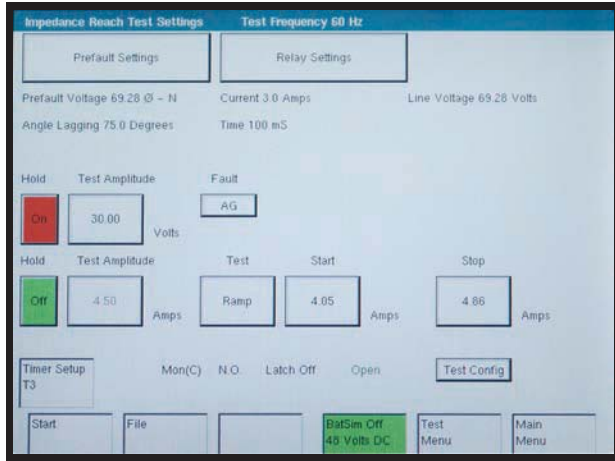

Impedance Reach Test Settings Screen

It should be noted that not only does the display screen show values of voltage, current and phase angle, but it also displays the current value where the relay should pick up, (different formulas for calculating OHMS are selectable using the touch-screen to select phase to phase or phase to ground faults). The user can select ramp current and hold fault voltage on ramp voltage and hold fault current.

The impedance test screen provides a pre-fault condition for those relays that require a pre-fault load prior to applying the fault. The test automatically determines values like reach, maximum angle of torque, and timing.

Finally, for testing multi-zone relays, the user can select the Pulse-Ramp method to determine operating points without needing to defeat the other zone timers. Test results can be saved to the internal memory for later download and review.

Also easily test relays not on the Preset Menu

Other types of relays or devices not specifically listed in the Preset Menu Screen can be tested using one of the Manual Test screens.

For example, negative sequence under/over voltage, reverse phase, phase sequence, and current balance relays may be tested using the Voltage/Current manual test screen. In addition, manual control of up to four voltages and currents, or up to 8 currents is done using this test screen.

Other devices such as auto-synchronizing, frequency sensitive devices and transducers also have their own individual manual test screens. The user manually selects the parameter(s) to be set or adjusted using the touch-screen and ramp outputs using the control knob. Each test screen has a dynamic enable capability and will either automatically step from a pre-fault, to fault, to breaker trip, to reclose, or automatically ramp frequency at a preprogrammed Hz/Sec, or time for a given slip frequency, depending on which screen is in use. In the Manual Auto-Synchronizing Test Screen, the advanced closing time and closing angle are automatically done in the dynamic mode.

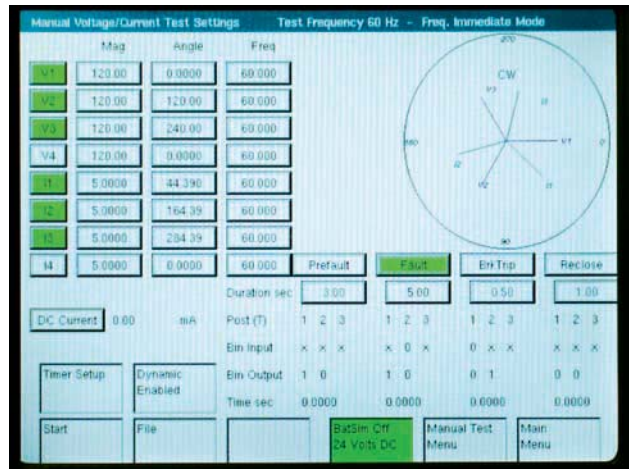

NEW Manual Voltage/Current Test System with Dynamic Enabled

In the Manual Test Screen shown above, the pre-selected outputs are set. The Green color indicates which output(s) have been selected. When the test is started by pressing the Start button, the selected output indicators will change colors from green to red indicating which outputs are energized. A vector graph indicates the relative phase angles of all of the outputs. All of the outputs are metered and displayed to provide real time verification of all of the selected outputs.

Even perform manual transducer testing

With the built-in transducer test screen, manually testing transducers has never been easier. The user simply selects from a pull-down menu, what type of transducer is being tested and enters information relative to the transducer's inputs and outputs. Upon starting the test, the test set automatically measures and calculates the % error of the device.

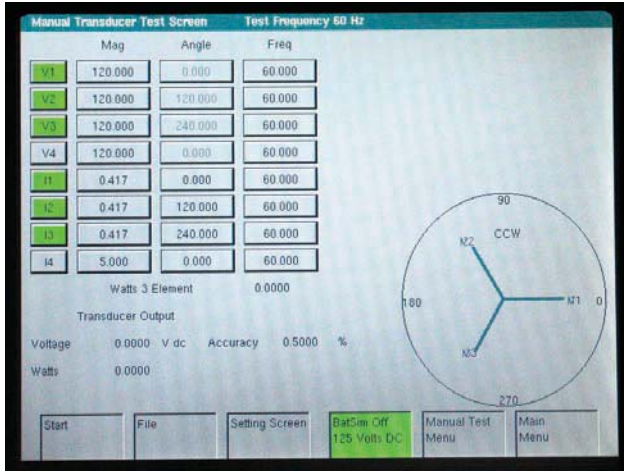

Transducer Test Screen

In the above example, a three-phase, 3 Element Watt Transducer is being tested. The actual output watts is calculated based upon the measured values from the MPRT into the transducer, and the transducer watts is calculated based upon the measured output voltage/current from the transducer. A % error is automatically calculated and displayed. A vector representation of the voltage and current outputs is also displayed.

Use the File Manager to organize all test results

The TVI has sufficient internal memory to save hundreds of test and result files. To manage the tests and results, the MPRT has a File Manager screen.

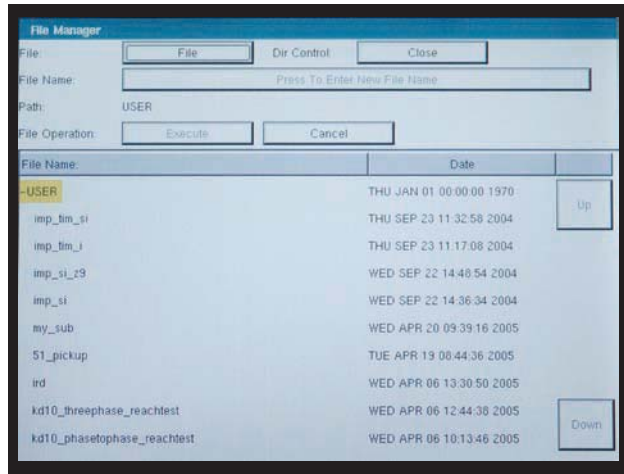

File Manager Screen

From any test screen, the user has access to the Test File Manager Screen. The user can give the test file/result file any name up to a maximum of 99 characters. Once saved, the user can recall the test and execute with the appropriate settings already set, or recall saved test results to download into the AVTS database for storage or for printing.

All output values are metered and displayed

When under automatic computer control (with the AVTS software), the TVI becomes a meter display for all of the MPRT outputs. The metered values are displayed to

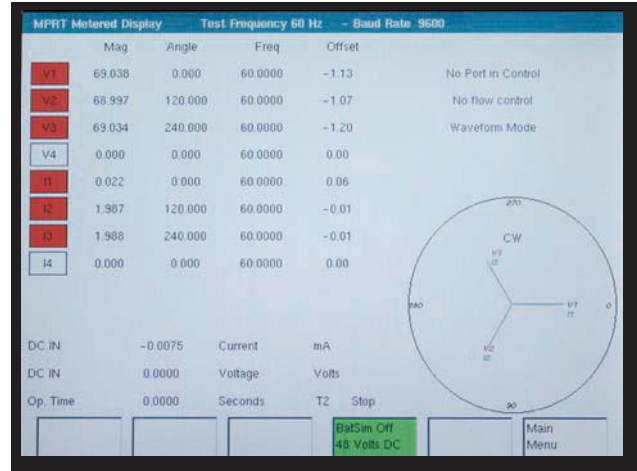

Meter Display Screen

provide continuous real-time verification of the MPRT outputs, even when under automatic control.

Output values are displayed with a vector display, which shows the vector relationship between the output voltage and currents.

User customized configuration

The user may customize how the unit displays phase angles (0-360° Lead/Lag or ± 180°), and set default values of voltages, currents and frequency. The user may also select a language for prompting the operator. Seven language choices are currently available, English, Chinese, French, German, Korean, Portuguese and Spanish.

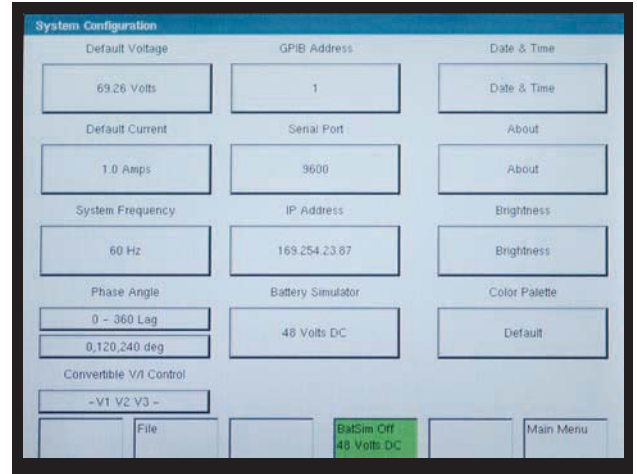

TVI Default Setting Screen

Other default settings include GPIB and IP addresses, Serial Port settings, Battery Simulator output and screen background colors.

AVTS SOFTWARE

See page 9 for details regarding AVTS Software.

FEATURES AND BENEFITS

- **Large Color LCD touch-screen display** - The TVI features an easy to use and read display providing manual control of the test set, and displays **measured** values of voltage, current, along with phase angle and frequency. Calculated values such as Ohms, Watts, VAR's and Power Factor may also be displayed, depending on the test screen in use. Color contrasts accentuate vital information. This reduces human error and time in testing relays.
- **Constant Output Power** - The new MPRT employees new high powered Voltage-Current amplifiers (VI-Gens). The current amplifier delivers maximum compliance voltage to the load constantly during the test. Constant output power in many cases eliminates the need to parallel current channels together to test high burden relays.
- **High resolution and accuracy** - The TVI has **Metered** outputs and a timer to provide extremely high accuracy. High accuracy extends testing capability to other devices such as transducers.
- **Internal memory** - The TVI provides storage of test set-up screens and test results. Reduces testing time and paper work. Saved test results can be downloaded into the AVTS software database.
- **Steady-State and Dynamic testing capability** - The MPRT provides, either through manual control or computer control, both steady-state and dynamic testing of protective relays. This includes programmable waveforms with dc offset and harmonics.
- **Display screen prompts operator** - The TVI features a display screen that prompts the user with easy to use function buttons. Single button operation saves time in testing relays and minimizes human error.
- **Display screen provides eight languages** - The TVI display screen prompts the user in English, Chinese, French, German, Korean, Japanese, Portuguese and Spanish.
- **Output current and voltage sinewaves are generated digitally** - MPRT outputs do not vary with sudden changes in input voltage or frequency, which increases test accuracy and reduces testing time.
- **Memory metering** - Allows the user to set test currents and voltages faster. Reduces heating of device under test.
- **Digital inputs and outputs** - MPRT has 10 programmable inputs, and 6 programmable outputs provide timing and logic operations in real-time with the output voltage and currents. Binary Inputs can be programmed, using Boolean logic, for more complex power system simulations. This provides a low cost, closed loop, power system simulator.
- **Circuit breaker simulator** - MPRT's binary outputs provide programmable normally closed and normally open contacts to simulate circuit breaker operation for testing reclosing relays. Sequence of operation, timing, and lockout are easily tested.



- **Performs transient tests** - Perform acceptance or troubleshooting tests by replaying digitally recorded faults or EMTP/ATP simulations in the IEEE- C37.111, COMTRADE Standard format.
- **Perform End-to-End tests** - Using AVTS software and a portable GPS satellite receiver, the MPRT performs satellite-synchronized end-to-end dynamic or transient tests. Provides precisely synchronized testing of remotely located complex protection schemes.
- **Wide-ranging output frequency** - The output frequency of the current and voltage channels can be set for any frequency from dc to 1 kHz. Popular test frequencies such as 25, 50, 60 and 100 Hz are easily set and controlled. Provides ultra-flexibility to save time and lower costs.
- **RS-232 serial port** - The RS-232 port provides a computer interface to perform automatic testing.
- **Ethernet port** - The Ethernet port provides a high-speed computer interface. This can be used to quickly download transient waveform data and update test set firmware via internet.
- **IEEE-488GPIB** - The IEEE-488 is an OEM preferred interface for control of the unit. This interface is preferred, when using the unit with other IEEE-488 devices. It can also provide high speed downloading of transient data.

- **Universal input voltage** - Operating from 90 to 264 Vac, 50/60 Hz, the MPRT can use virtually any standard source in the world.
- **Battery simulator** - MPRT's battery simulator provides dc output voltages of 24, 48, 125 and 250 Volts. Eliminates needing a separate dc source for providing logic voltage for microprocessor-based relays.
- **Immediate error indication** - Audible and visual alarms indicate when amplitude or waveforms of the outputs are in error.
- **Modular design** - Output modules plug-in and slide out easily for system re-configuration and maintenance.
- **Ancillary Interface** - Provides interface to other MPRT units.
- **MPRT Model 8430** - Provides up to 300 Volts rms. at 150 VA and 30 Amps rms. at 200 VA per phase. Ample voltage for testing high instantaneous overvoltage relays. The current amplifier has high compliance voltage at low currents for testing ground overcurrent relays. When configured with four channels, the current amplifiers can be paralleled to provide a maximum of 120 Amperes at 800 VA, for testing instantaneous overcurrent relays. With high VA output ratings, the unit can be used for testing a panel of relays.
- **MPRT Model 8415** - Provides up to 150 Volts rms. at 150 VA and 15 Amps rms. at 200 VA per phase. This lower cost unit is ideal for testing relays used with 1 Amp secondary CT's. The current amplifier has high compliance voltage at low currents for testing ground overcurrent relays. When configured with four channels, the current amplifiers can be paralleled to provide a maximum of 60 Amperes at 800 VA, for testing instantaneous overcurrent relays. With high VA output ratings, the unit can be used for testing a panel of relays.

SPECIFICATIONS

Input Power

100 to 240 Volts, ±10%, AC, 1Ø, 50/60 Hz, 2100 VA.

Outputs

All outputs are independent from sudden changes in line voltage and frequency. This provides stable outputs not affected by sudden changes in the source. All outputs are regulated so changes in load impedance do not affect the output. Each output module consists of one current amplifier, and a voltage amplifier. The voltage amplifier may be converted to a current source. Therefore, one amplifier module may be used to test current differential relays, including harmonic restraint.

Output Current

The following specifications cover both Model 8430 and Model 8415 modules. Outputs are rated with the following:

Model 8430

Per phase:

| Output Current | Power | Max V |
|----------------|-----------|-----------|
| 4 Amperes | 200 VA | 50.0 Vrms |
| 7.5 Amperes | 200 VA | 26.7 Vrms |
| 15 Amperes | 200 VA | 13.4 Vrms |
| 30 Amperes | 200 VA | 6.67 Vrms |
| DC | 200 Watts | |

With two currents in parallel:

| Output Current | Power | Max V |
|----------------|--------|-----------|
| 8 Amperes | 400 VA | 50.0 Vrms |
| 15 Amperes | 400 VA | 26.7 Vrms |
| 30 Amperes | 400 VA | 13.4 Vrms |
| 60 Amperes | 400 VA | 6.67 Vrms |

With three currents in parallel:

| Output Current | Power | Max V |
|----------------|--------|-----------|
| 12 Amperes | 600 VA | 50.0 Vrms |
| 22.5 Amperes | 600 VA | 26.7 Vrms |
| 45 Amperes | 600 VA | 13.4 Vrms |
| 90 Amperes | 600 VA | 6.67 Vrms |

With four currents in parallel:

| Output Current | Power | Max V |
|----------------|--------|-----------|
| 16 Amperes | 800 VA | 50.0 Vrms |
| 30 Amperes | 800 VA | 26.7 Vrms |
| 60 Amperes | 800 VA | 13.4 Vrms |
| 120 Amperes | 800 VA | 6.67 Vrms |

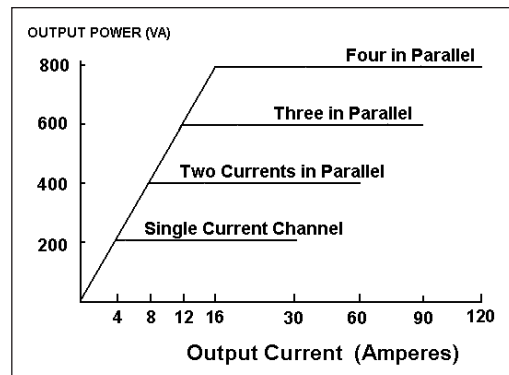

Power Curve for Model 8430

With two currents in series, the compliance voltage doubles to provide 4.0 Amperes at 100 Volts.

Model 8415

Per phase:

| Output Current | Power | Max V |
|----------------|-----------|-----------|
| 4 Amperes | 200 VA | 50.0 Vrms |
| 7.5 Amperes | 200 VA | 26.7 Vrms |
| 15 Amperes | 200 VA | 13.4 Vrms |
| DC | 200 Watts | |

With two currents in parallel:

| Output Current | Power | Max V |
|----------------|--------|-----------|
| 8 Amperes | 400 VA | 50 Vrms |
| 15 Amperes | 400 VA | 26.7 Vrms |
| 30 Amperes | 400 VA | 13.4 Vrms |

With three currents in parallel:

| Output Current | Power | Max V |
|----------------|--------|-----------|
| 12 Amperes | 600 VA | 50 Vrms |
| 22.5 Amperes | 600 VA | 26.7 Vrms |
| 45 Amperes | 600 VA | 13.4 Vrms |

With four currents in parallel:

| Output Current | Power | Max V |
|----------------|--------|-----------|
| 16 Amperes | 800 VA | 50 Vrms |
| 30 Amperes | 800 VA | 26.7 Vrms |
| 60 Amperes | 800 VA | 13.4 Vrms |

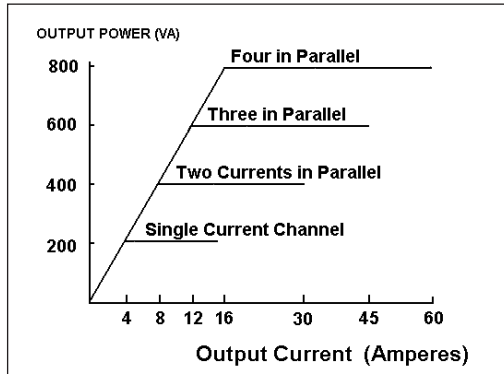

Power Curve for Model 8415

With two currents in series, the compliance voltage doubles to provide 4.0 Amperes at 100 Volts.

AC Voltage Output

The following specifications cover both the Model 8430 and 8415 modules. Outputs are rated with the following Ranges:

Model 8430

Per phase:

| Output Volts | Power | Max I |
|--------------|-----------|--------|
| 30 Volts | 150 VA | 5 Amps |
| 150 Volts | 150 VA | 1 Amp |
| 300 Volts | 150 VA | 0.5 A |
| DC | 150 Watts | |

With two voltages in series:

| Output Volts | Power | Max I |
|--------------|--------|--------|
| 60 Volts | 300 VA | 5 Amps |
| 300 Volts | 300 VA | 1 A |
| 600 Volts | 300 VA | 0.5 A |

With three converted sources in parallel:

| Output Current | Power | Max V |
|----------------|--------|---------|
| 15 Amperes | 450 VA | 30 Vrms |

Model 8415

Per phase:

| Output Volts | Power | Max I |
|--------------|-----------|--------|
| 30 Volts | 150 VA | 5 Amps |
| 150 Volts | 150 VA | 1 Amp |
| DC | 150 Watts | |

With two voltages in series:

| Output Volts | Power | Max I |
|--------------|--------|--------|
| 60 Volts | 300 VA | 5 Amps |
| 300 Volts | 300 VA | 1 A |

With three converted sources in parallel:

| Output Current | Power | Max V |
|----------------|--------|---------|
| 15 Amperes | 450 VA | 30 Vrms |

Battery Simulator

The battery simulator provides the following DC output: 24, 48, 125 or 250 Volts at 100 Watts. Voltage output is controlled via the Touch-View Interface, or through AVTS software.

Metering

Measured output quantities such as AC Amperes, AC Volts, DC Volts or DC Amperes, and Time may be simultaneously displayed on the large, variable contrast, color LCD touch screen. The memory feature of the metering provides fast and accurate preset of test values. The AC and DC outputs display the approximate voltage/current output prior to initiation of the outputs. This provides a fast, easy method for preset of outputs. Other values that may be displayed, depending on which test screen is in view, are phase angle, frequency, Ohms, Watts, VARS and Power Factor. All Accuracies stated are from 10 to 100% of the range at 50/60 Hz.

AC Voltage Amplitude

Accuracy: ±0.05% typical, 0.1% guaranteed.
Resolution*: .0001/.001/.01
Measurements: True RMS

AC Current Amplitude

Accuracy: ±0.05% typical, 0.1% or ±20 mA, which ever is greater, guaranteed.
Resolution: .0001/.001
Measurements: True RMS

DC Voltage Amplitude

Accuracy: ±0.1% typical, 0.25% guaranteed.
Resolution*: .0001/.001/.01
Measurements: True RMS

DC Current Amplitude

Accuracy: ±0.1% typical, 0.25% or ±20 mA, which ever is greater, guaranteed.
Resolution: .0001/.001
Measurements: True RMS

Convertible Source in AC Current Mode

Accuracy: ±0.05% typical, 0.1% or ±12.5 mA, which ever is greater, guaranteed.
Resolution: .0001
Measurements: True RMS

Phase Angle

Ranges 0.01 to 359.99 degrees, Counter Clock Wise, or Clock Wise rotation, or ±0.01 to ±180.00 degrees
Accuracy: ± 0.02° typical
 ± 0.25° at 50/60 Hz max

Frequency:

The output modules provide a variable frequency output with the following ranges and accuracy.

Ranges

DC
 0.001 to 1000.000 Hz

Output amplifiers can provide transient signals with a range of DC to 10 kHz for transient playback.

Resolution*: .0001/.001 Hz
Frequency Accuracy:
 2.5 ppm typical
 25 ppm 0° to 50° C, at 50/60 Hz

Total Harmonic Distortion:

Less than 0.1% typical,
 2% maximum at 50/60 Hz.

* Resolution of Voltage and Frequency Magnitudes are adjustable to three decimal places with the TVI and to four decimal places with AVTS Vector and Ramp Controls.

Power

The Watts displayed is the calculated value based on the displayed formula. Nine different formulas are available.
 Range: 0 to 15 kW
 Accuracy: $\pm 0.525\%$ of VA ± 1 least significant digit

The DC IN input terminals

Range:
 0 to ± 10 V DC
 0 to ± 20 mA DC
Accuracy: $\pm 0.02\%$ Typical
 $\pm 0.05\%$ Max
Measurements: Average

Timer-Monitor

The Timer-Monitor (Binary Inputs) are designed to monitor and time-tag inputs, as a sequence of events recorder. In addition, the binary input controls enable the user to perform logic AND/OR functions on the inputs, and conditionally control the binary output relays to simulate circuit breaker, trip, reclose and carrier control operation in real-time. The Timer function displays in Seconds or Cycles, with the following range and resolution:

Seconds: 0.0001 to 99999.9

(Auto Ranging)

Cycles: 0.01 to 99999.9

(Auto Ranging)

Accuracy: $\pm 0.001\%$ of reading, typical. ± 2 least significant digit, $\pm 0.005\%$ of reading from 0 to 50° C maximum.

Binary Inputs- Start/Stop/Monitor Gates

10 identical, independent, galvanically isolated, Start/Stop or Monitor circuits are provided. To monitor operation of relay contacts or trip SCR, a continuity light is provided for each input gate. Upon sensing continuity the lamp will glow and a tone generator will sound. In addition to serving as wet/dry contacts the Binary Inputs may be programmed to trigger binary output sequence(s). Binary Inputs can also be programmed using Boolean logic for more complex power system simulations.

Input Rating: up to 300 V AC/DC

Binary Output Relays

6, independent, galvanically isolated, output relay contacts accurately simulate relay or power system inputs to completely test relays removed from the power system. Binary outputs simulate normally open / normally closed contacts for testing breaker failure schemes. Outputs can be configured to change state based on binary input logic (Boolean logic is available for more complex simulations), or a specified time delay after a logic input condition.

High speed relays: 2 each

AC/DC Rating: 400 V peak, 1 A max.

Output Relays: 4 each

AC Rating: 400 V max., I_{max}: 8 amps, 2000 VA max. breaking capacity

DC Rating: 300 V max., I_{max}: 8 amps, 80 W

Waveform Generation

Each output channel can generate a variety of output waveforms such as: DC; sinewave; sinewave with percent harmonics at various phase angles; half waves; square waves with variable duty cycles; exponential decays; periodic transient waveforms from digital fault recorders, relays with waveform recording capability or EMTP/ATP programs, which conform to the IEEE C37.111 COMTRADE standard format. In addition, each output channel has input BNC connector for amplification of external analog signals.

Waveform Storage

Each output channel can store waveforms for playback on command. End-to-end playback of stored waveforms is possible, when triggered externally by a GPS receiver. Each channel can store up to 256,000 samples.

Protection

Voltage outputs are protected from short circuits and prolonged overloads. Current outputs are protected against open circuits and overloads.

Ancillary Interfaces

On the back panel of the MPRT are the RS-232, Ethernet, IEEE-488 GPIB, Trigger In, Trigger Out, Clock In, and Clock Out.

Temperature Range

Operating: 32 to 122° F (0 to 50° C)

Storage: -13 to 158° F (-25 to 70° C)

Relative Humidity: 5 - 90% RH, Non-condensing

Dimensions

Unit Enclosure

17.2 W x 8.75 H x 18.5 D* in. (430 W x 218 H x 463 D mm)

*Includes 2.5" depth of floor stand-offs

Weight

Weight varies depending on the number of output modules in the system. The weights shown below are for a complete three-phase test system.

Model 8415:

41.8 lb. (18.9 kg)

Model 8430:

41.8 lb. (18.9 kg)

Safety, EMC, RFI and ESD Conformance

IEC 61010-1, Amendments 1 and 2, EN 50081-2, EN 50082-2, EN 61000-3-2, 61000-3-3, IEC 61000-4-2/3/4/5/6/8/11.

Shock, Vibration and Temperature

To simulate the worst field conditions the unit was tested in accordance with Military Standard MIL-STD-810 for temperature, humidity, shock, and vibration.

Enclosure and Transit Cases

The unit comes mounted in a rugged enclosure for field portability. There are three versions of the enclosure. The L version has carry handles on the sides for easy mobility, and a carry strap that connects to the chassis. Small fold up feet built into the bottom of the chassis serve to tilt the face of the unit up when operating on a bench top. The enclosure has vertical stand-offs on the back that allows the unit to be operated vertically off the floor. The H version is the same as the L with an additional



MPRT in optional soft-sided case.



One-piece hard-sided case.



Two-piece hard-sided case.

extra large adjustable carry handle that can also be used to tilt the face of the unit up. The H version does not come with a carry strap. Both units may be carried in the optional soft sided carry case, Part Number 684011. The soft sided case has approximately 1 inch thick padding, which provides moderate protection against rain, dust, vibration and shock. For higher level transit protection, optional custom made hard sided transit cases are available. The one piece transit case, part number 684019, provides protection for the MPRT and the Touch View Interface, as well as provides storage facilities for the power cord, interface cables and test leads. The case has built-in wheels and a telescoping handle. The two piece hard sided transit case also has built-in wheels and a telescoping handle, part number 674002. The two piece hard

sided transit case was specifically designed to reduce the size and weight for those who use commercial airlines. Therefore, only the L version will fit in the two piece case (the H version is heavier by about 2.2 pounds or 1 kg). The larger of the two pieces is designed to carry the MPRT. The second smaller case has storage space for the TVI, power cord, interface cables and test leads. The weight of a 3 channel MPRT unit in the two piece transit case is approximately 66 pounds or 29.7 kg. The weight of the second case with test leads will vary depending on the number of test leads stored. Typically the weight will be about 27 pounds or 12.2 kg. The last version of the unit enclosure is the R version, or rack mount version. The R version includes rack mounting hardware to fit a standard 19 inch rack.

AVTS
Advanced Visual Test
Software Version 3.1

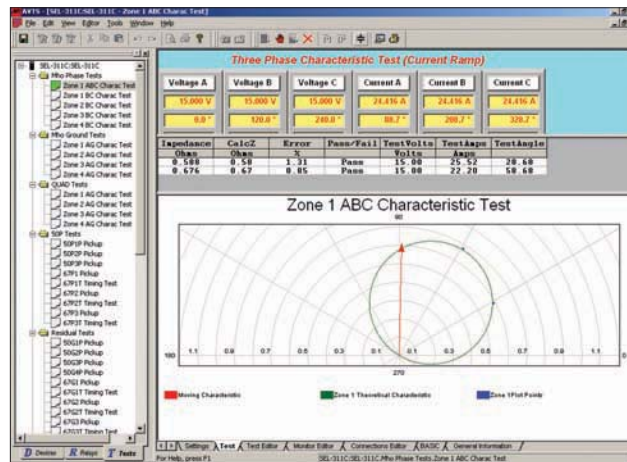

DESCRIPTION

AVTS is a Microsoft® Windows® 2000/XP®/Vista™ software program designed to manage all aspects of protective relay testing using the new Megger MPRT or older PULSAR relay test sets. More flexibility has been added as well as some new and powerful features.

AVTS 3.1 comes in three different levels:

- **Basic**
- **Advanced**
- **Professional**

Every MPRT unit comes with AVTS Basic.

The **Basic** version includes Online Vector, Ramp and Click-On-Fault controls with the ability to import, save and execute test modules. In addition, the Basic version includes enhanced Relay Test Wizards, including new wizards not previously available.

The **Advanced** version includes the Test Editor, Dynamic Control, Modbus, SS1 Converter, End-to-End test macros and basic programming Tools for creating and editing test modules.

The **Professional** version includes all of the features of the Basic and Advanced versions plus some new and powerful features. It includes the DFR Waveform Viewer, One-Touch Test, editor, and Waveform Digitizer.

APPLICATIONS

Using the Online Ramp Control, traditional steady-state tests are easily performed with AVTS by simply applying test quantities to the device under test and automatically ramping the current, voltage, phase angle or frequency.

Using either the Online Ramp, Vector or Dynamic Controls, Dynamic tests can easily be performed. The dynamic test includes setting a pre-fault condition and allowing the software to automatically test/search for the operating characteristic of the relay by selecting one of several available methods. Using Test Wizards or Test Modules, fault types are selected from a pull-down window.

Operating characteristics for virtually any type of relay are easily defined using Mho circles, Lenticular, Tomato characteristics, or a combination of lines, line and slope, time and amplitude, calculated value or theoretical object (a time-current curve may be scanned into the program using the digitizer feature in either the Advanced or Professional versions of AVTS).

The AVTS Test Screen enables the user to view test values (both theoretical and actual) on one screen. For example, the figure above shows test values, both theoretical and actual results, all on one screen.

The chart on the following page provides an easy reference showing the features of each version of AVTS Software.

| AVTS 3.1 | | Basic | Advanced | Professional |
|---|--|-------|----------|--------------|
| Feature | Description | | | |
| Online Vector Control | The Online Vector Control allows the user to have direct control of the Relay Test System. Up to sixteen vector states may be created and sequenced back through the test system. Now includes timer function for timing a given vector state. | ■ | ■ | ■ |
| Online Ramp Control | Preramp (prefault), Ramp 1 and Ramp 2 are available for use to be played back through the test system. Automatically Ramp or Pulse Ramp outputs. PulseRamp provides the capability to determine reach points on multi-zone distance relays without having to defeat the zone timing elements, and provides pre-fault load conditions for relays that require it. Enable timer control with either ramp. PulseRamp is available down to the basic level. | ■ | ■ | ■ |
| On-Line Click On Fault NEW | The user can define the type of operating characteristic using the AVTS Theoretical Control or Import files in the RIO file format, then click at a point on the characteristic that they wish to test for, either as a Shot, or using the Search features. If using the Search the test will progress down a line, using click and drag, either as a ramp or a pulse ramp looking for the relay to operate. Test results appear in the RX diagram along with the theoretical operating characteristic of the relay. | ■ | ■ | ■ |
| RIO File Format NEW | RIO file import allows the user to import an existing RIO file into the click-on-fault R/X diagram ready to proceed with the test. | ■ | ■ | ■ |
| DFR Playback | Import and execute relay test modules, which contain DFR playback files created using the DFR Waveform Viewer Tool. | ■ | ■ | ■ |
| Fault Calculator | Calculate fault values for \emptyset - \emptyset , \emptyset -N, and 3 \emptyset faults. Use line voltage, line Z and angle, relay volts and angle, relay amps and Z0/Z1. | ■ | ■ | ■ |
| Import, Save, and Execute Test Modules | Import relay test files and execute selected tests. Save results to built-in Microsoft Access compatible data base, and print results. | ■ | ■ | ■ |
| Overcurrent Wizard | Provides automatic testing of overcurrent relays, including pickup, timing characteristic using IEEE / IEC formulas, Instantaneous, DC target and seal-in tests. | ■ | ■ | ■ |
| Over/Under Voltage Wizard | Provides automatic testing of over and under voltage relays, including pickup, timing characteristic and DC target and seal-in tests. | ■ | ■ | ■ |
| Distance Wizard | Provides automatic testing of distance relays. \emptyset - \emptyset , \emptyset -G, and 3 Phase faults are available. Test result graphics are displayed in an R X plane. | ■ | ■ | ■ |
| Differential Wizard | Provides automatic testing current differential relays, including pickup, slope (includes capability to control up to 8 currents for differential characteristic), and 2nd, 3rd and 5th harmonic restraint tests on transformer differential relays. | ■ | ■ | ■ |
| Directional Wizard | Provides automatic testing capability of directional elements. | ■ | ■ | ■ |
| Frequency Wizard NEW | Provides automatic testing of under/over frequency relays, including pickup and timing. | ■ | ■ | ■ |
| Transducer Testing with Touch-View Interface or AVTS software | Use the TVI to do manual testing of all types of transducers. Results maybe saved to the internal memory, downloaded to AVTS and printed later. AVTS users may create a test for any type transducer using the Test Editor Screen and the Analog Input control tool. | ① | ■ | ■ |
| Test Editor | Provides editing tools for modifying tests. | | ■ | ■ |

| Feature | Description | Basic | Advanced | Professional |
|-------------------------------------|--|-------|----------|--------------|
| Dynamic Control NEW | Accessed through the Test Editor Screen, the Dynamic Control provides dynamic multi-state testing of relays with more flexibility and choices than Vector Control. A “state” can be voltage(s), current(s), phase angle(s), timers, start and stop the analog recorder, set Boolean logic for the binary inputs, set binary output(s), or even use variables to set values. The test transitions from one state to another after a programmed time delay of either milliseconds or cycles, or after a trigger condition. In addition, the Dynamic Control allows the user to easily build harmonic waveforms with frequencies up to 1000 Hz. | | ■ | ■ |
| Basic Programming Tool | Provides control tool in the Test Editor. Basic programs can be written using the test system command set for special testing applications. | | ■ | ■ |
| Modbus Communications NEW | Used in conjunction with specific Megger Test Modules to automatically download relay settings (into the AVTS setting screen) from microprocessor based relays, which use the Modbus protocol, for full automatic one-touch testing. | | ■ | ■ |
| SS1 File Converter NEW | SS1 files are generated using Power System Simulation software programs by Electrocon® CAPE™ or Aspen One-liner® . By modeling the power system and using the SS1 files, the relay can then be tested dynamically using realistic system test scenarios. | | ■ | ■ |
| Import Aspen Relay Database® | Capability to import relay settings directly from Aspen Relay Database® | | ■ | ■ |
| End-to-End Test Macro | “End-to-End” testing is used to describe the testing of an entire line protection scheme. This includes all protective relays, interface equipment, and any communication equipment. | | ■ | ■ |
| Recorder NEW | In association with the new Dynamic Control is a new Recorder feature, which not only records the action of the binary inputs and outputs, but it also records the actual analogue waveforms of the MPRT voltage and current outputs. Use this new feature to capture and verify analogue output values. Use to monitor Binary Inputs and Outputs to capture and troubleshoot single-pole or three-pole coordination or suspected contact bounce situations. Use to capture multi-state playback to evaluate complex reclosing schemes. It will even record complex waveforms generated by the MPRT, which could be used for harmonic evaluations. | | ■ | ■ |
| Waveform Digitizer | Provides digitizing tools to create digital time curves for old electromechanical relay time curves (that do not fit any time curve algorithm) up to the most complex relay operating characteristics. Good for digitizing scanned waveforms (like from a light-beam chart recorder). | | | ■ |
| One-Touch | Test Editor control tool, used in conjunction with specific Megger Test Modules, to download relay settings (into the AVTS settings screen) from microprocessor based relays for full automatic one-touch testing. Used with VB script to auto test SEL relays and new MODBUS to auto test GE UR and selected Multilin relays. | | | ■ |
| DFR Waveform Viewer and Playback | Import, view, modify and replay Digital Fault Recordings or EMTP/ATP simulations that are in the COMTRADE file format. | | | ■ |

AVTS BASIC VERSION

There are three versions of AVTS software. **The Basic version is included with each MPRT unit.** The Advanced and Professional versions are optional. The Basic version includes online Vector, Ramp and Click-On-Fault controls, relay testing wizards for most types of relays, the ability to import, save and execute relay specific test modules created either by Megger or someone else with either an Advanced or Professional version of AVTS 3.1. Basic can also playback a DFR file created using the Professional version of AVTS. The following describes the features of the Basic version of AVTS 3.1.

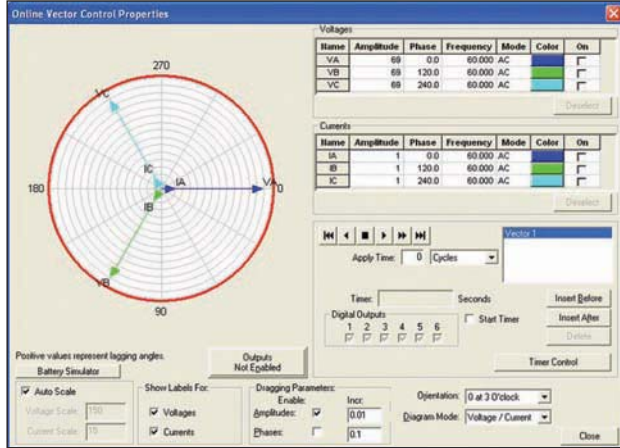

Online Vector Control

Online Vector Control

The **Online Vector Control**, launched from the AVTS Tools menu item, allows the user to have direct control of the Relay Test System. Up to **sixteen vector states** may be created and played back through the Relay Test System. A **timer control** is available to enable starting the Relay Test System timer at the execution of any one of the vector states. The timer stop is typically controlled by an action from one of a device’s outputs connected to the appropriate Relay Test System timer stop gate. The default view of the Online Vector Control remains visible during all use of the control.

For **manual ramping** of amplitudes and phases, a **gang control** is available through the selection of the vectors (Relay Test System amplifiers) to be controlled. The vectors to be controlled in gang are selected by using the mouse to grab and alter the vector(s) parameters. Vector selection is made by clicking on a vector channel name to highlight that vector with its parameters. Should it be desired to simultaneously control more than one vector, the user will need to click on the wanted vectors while holding the keyboard Ctrl key down to highlight all of the selected vectors. The user may then select from the **‘Dragging Parameters’** box whether the amplitudes and/or phases of the selected vectors are to be active. Once selected, the user can grab the tip of any of the selected vectors in the polar graph and, while holding the left mouse button down, move the vector(s). The values of the vector(s) will change graphically and numerically, and simultaneously pass the new values directly to the corresponding Relay Test System amplifiers. Some other unique features are:

Aux Contact Check Box- will close an “aux” binary output contact conditional with change from one vector state to another.

Edit Custom Prefix Command- available for each vector state and allows entry of a formula, Relay Test System syntax, or other controlling variable for that selected vector state.

Zoom- enlarges the polar vector diagram to the full dimensions of the dialog box.

Favorites - save a single vector, or a set of multiple vectors, with all the parameters to a desired name for recall at a later time in the Online Vector Control (Basic Version) or the Test Editor Vector Control (requires Advanced version). Save to the name placed in the edit field will retain only the selected vector(s) in the vector list. The Edit Customs Prefix Commands are saved along with the generator parameters.

Set to Variables - selection replaces the numeric values for all the vector parameters to known default variable names. This function is more commonly used for the Vector Control used within a test development in the Test Editor (Advanced Version), where the variable names are given values in the Settings Screen, Variable Watch edit field (a powerful programming tool in the Advanced version) in the Test Screen, or in another control in the Test Editor (Advanced version) Screen prior to the Vector control.

Online Ramp Control

The **Online Ramp Control**, launched from the AVTS Tools menu item, allows the user to have direct real time control of the Relay Test System. This control is very similar to the Online Vector Control. However, where the

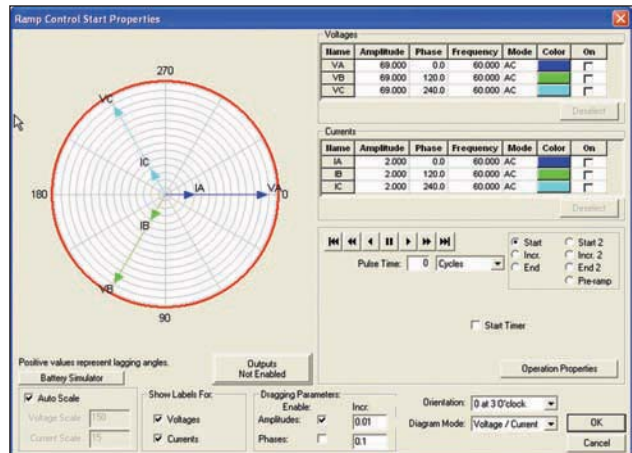

Online Ramp Control

vector control sequences through up to 16 different states, the Ramp Control provides automatic ramping of selected outputs to do pick-up or drop outs tests of amplitude, phase angle or frequency. Pre-ramp, Ramp 1 and Ramp 2 are available for use to be played back through the Relay Test System. A timer control is available to enable starting the Relay Test System timer at the execution of either of the ramp states. The timer stop is typically controlled by an action from one of a device’s outputs connected to the timer stop gate.

Similar to Online Vector Control, Online Ramp Control provides manual ramping of amplitudes and/or phases. The gang control is similar through the selection of the vectors (Relay Test System amplifiers) to be controlled. The outputs to be controlled in gang are selected by using the mouse to grab and alter the parameters (see Online Vector Control for more details). Another feature of the Online Ramp Control is the ability to do **Pulse Ramping**. One advantage of Pulse Ramping is the capability to determine reach points on multi-zone distance relays without needing the defeat the zone timing elements. For relays which require a pre-fault load condition prior to applying a fault value, the Online Ramp Control has a Pre-ramp (Pre-fault) state. This feature allows the user to apply the appropriate load values before Pulse Ramping begins. After applying a fault value the Ramp Control returns to the Pre-ramp state before the next value is applied. Many of the same features in the Online Vector Control are also available in the Ramp Control, such as the **Zoom, Set Variables** and **Favorites**.

On-Line Click-On-Fault Control

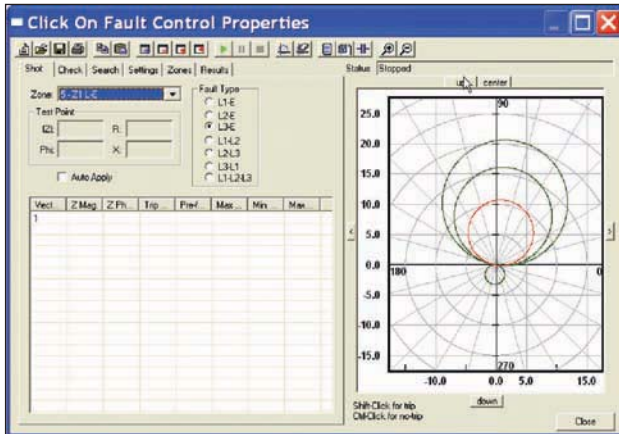

Click-On-Fault Test Screen with Multi-Zone Mho Distance Relay

Online Click-On-Fault, launched from the AVTS Tools menu item, allows the user to quickly test impedance relay characteristics. The user can define the type of operating characteristic using the AVTS Theoretical Control, where the user can select a Mho circle, Ellipse, Tomato or virtually any operating characteristic. Characteristics can also be predefined and imported using either the Theoretical Object File Import or RIO File Import. To test the user simply selects the type of fault desired (Line to Earth, Line to Line etc) and clicks to set a test point, either as a Shot, or using the Search. Multiple test points maybe selected and the software will automatically calculate the appropriate test currents and phase angles based upon the Settings and the Fault Type selected. In the Settings screen the user can define Constant Voltage, Constant Current or Constant Source Z (defined by Source Z, Source Angle and K). If using the Search the test will progress down a line, using click and drag, either as a ramp or a **pulse ramp** looking for the relay to operate. Test results are automatically displayed for each test point.

RIO File Import

In association with the Click-On-Fault test screen, Megger has also included a feature called RIO Import. RIO is a file format that defines the operating characteristic of specific relays. Customers who already have RIO files for their relays can import them into the Click-On-Fault RX diagram ready to test. Shown below is a RIO file import for a SEL 321 relay. Six shot test points are defined.

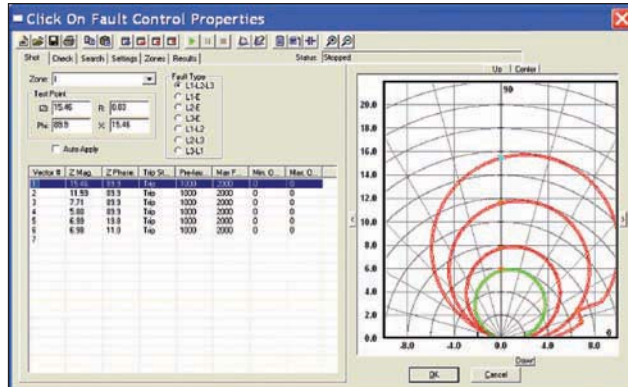

Click-On-Fault RIO Import of SEL 321 Characteristic

Test Wizards

All versions of AVTS software come with test wizards. The wizards walk the user through a step by step procedure to create a relay specific test(s). Wizards are available for the most common types of relays such as, Overcurrent, Over/Under Voltage, Frequency, Differential, Distance, Synchronizing and Directional. The following is a brief description of each test wizard.

Overcurrent Wizard - Provides automatic pickup, instantaneous pickup and timing. IEEE and IEC time curve algorithms are provided for automatic evaluation of the results. Digitized time curves for various electromechanical overcurrent relays are also available. For North American relays, a dc target and seal-in test is available. A test report will provide pass/fail information of the test results.

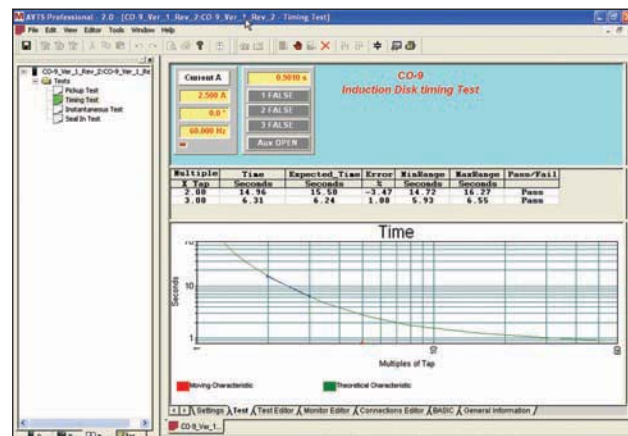

Over/Under Voltage Wizard - Provides automatic pickup and timing. A test report will provide pass/fail information of the test results based on user input.

Differential Wizard - Perform automatic winding pickup, differential characteristic (slope) test and harmonic restraint tests. In the figure below, the test result screen was resized using the mouse and the windows drag and drop feature. This allows the operator to more closely examine test points and results. The user may then generate a test report with the test results showing pass/fail based upon input by the user.

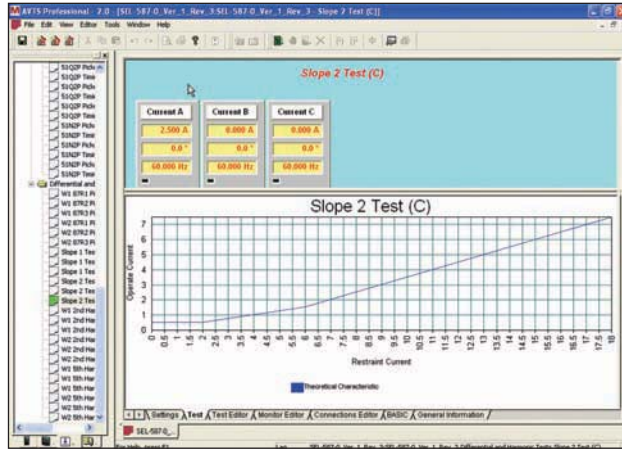

Resized Differential Slope Test Screen

Distance Wizard - Perform automatic reach, max angle of torque and characteristic tests on single phase, three phase open delta or three phase Y connected relays. User may choose between fixed voltage and vary current or fix current and vary voltage. In addition, the user may select mho, lens, tomato or other basic distance characteristics using a pull-down menu. The test report will provide pass/fail information based upon user data input.

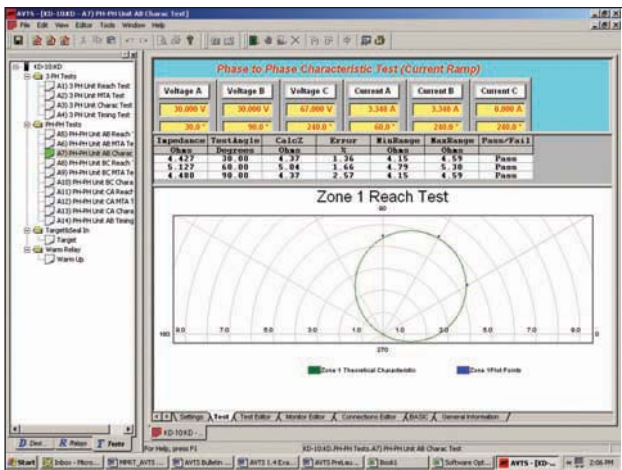

Typical Phase to Phase Characteristic Test

Directional Wizard - Perform automatic pickup test on directional elements. A report will provide test result.

Import, Save, Execute Test Modules

AVTS Basic Test users can import test modules generated by Megger, or someone else using the Advanced or Professional versions of AVTS. The user can execute the tests, save results and print results. In addition, users can playback a Digital Fault Record, which has been generated by the Professional version of AVTS 3.1.

Database

The database is Windows Access compatible. Data is saved in a conventional tree format to facilitate ease of use.

The following figure illustrates the AVTS navigator Relay tab when AVTS is in use. The relay data has been expanded to illustrate the organization.

The Organization is the method used to geographically locate the relays installed in this database.

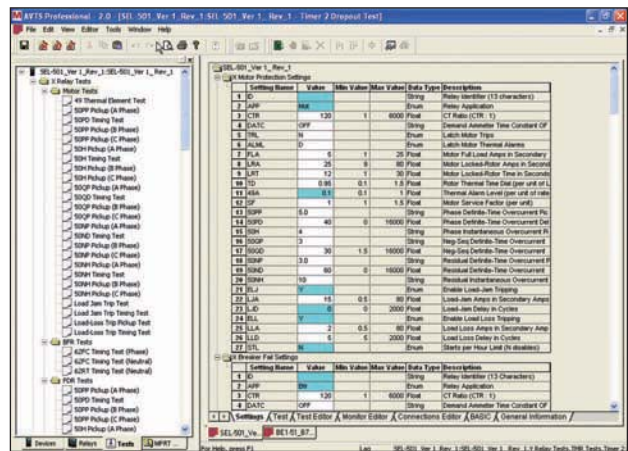

This example shows the organization tree descending by region, then substation, line, panel and finally the actual relay in the panel. The relays installed are then listed under that location. The heirarchical structure of AVTS includes up to 5 levels of organization.

In addition to showing the location of the relays in the system, the user can also look at the historical test records of any individual relay.

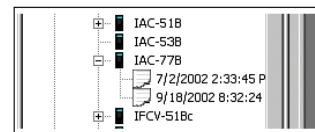

Test History for IAC77 Relay

Test Reports

Individual test results can be viewed by double clicking on the desired result file. The test report can either be printed, or exported to Microsoft Word for user customized report generation using company logo, company standard format etc.

Fault Calculator

The Fault Calculator allows the user to automatically calculate fault quantities for phase-to-phase, phase-to-ground and three-phase faults. The user inputs variables for: line voltage, line Z with angle, relay volts with angle, relay amps and Z0/Z1. The Z0/Z1 system impedance ratio is applied to both the source Z and the line Z for all faults which include ground.

AVTS ADVANCED VERSION

The Advanced version includes all of the features previously described for the Basic version. In addition, it includes the very powerful Test Editor, Connection Editor, Dynamic Control, Analog Recorder, Basic Programming Tool, Modbus communications, SS1 File Connector, End-to-End test macros, and generic pre-constructed relay test modules. Advanced users can also playback a DFR file created by someone using the Professional version of AVTS. The following describes the additional features of the Advanced version of AVTS 3.1.

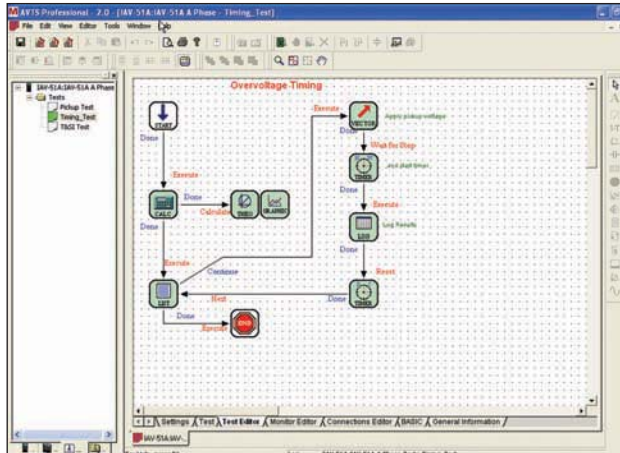

Test Editor Window

Test Editor

The real power of AVTS is in the Test Editor window. No more complicated test macros to write or edit. Instead, the user selects from a variety of icons representing various test macro functions. For example, in the following Figure, certain icons are selected and connected using the mouse. The software takes care of the rest. No more theoretical characteristic macros to write either. Simply click on the appropriate icon and drop into the test editor window. What may have taken days or weeks to “write” using basic programming now takes only minutes!

In addition, the test wizards automatically assemble and connect the appropriate icons for you. All you need to do is edit the appropriate control function to meet your specific needs. For example, using a right-mouse click on the Ramp Control Icon (in the Test Editor work screen), and then clicking on the Increment button, the user is able to adjust the increment value of each current increment for a pickup test.

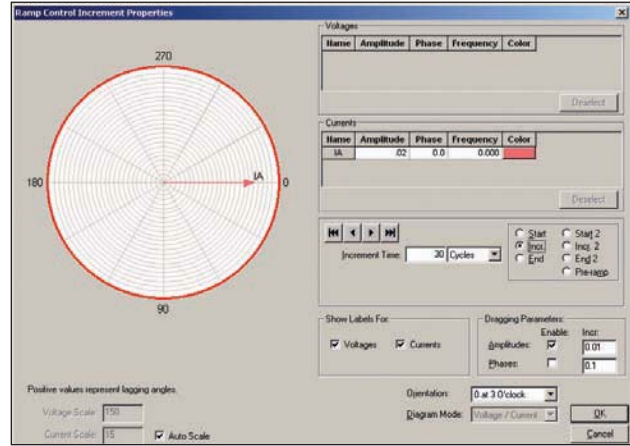

Adjusting Ramp Control- Current Increment

Connections Editor

A picture is worth a thousand words. It seems like modern relays need a thousand connections today, so the Connections Editor is ideal to show how to connect the test system to the device under test. Powerful graphic tools are available to show test connections (see following Figure).

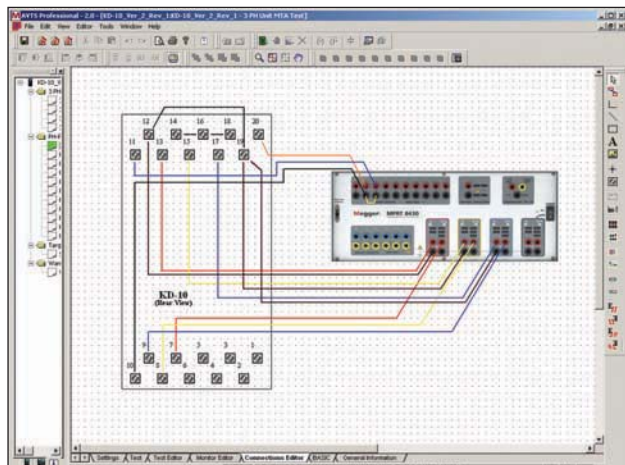

Connections Editor Screen provides relay test connections details

The Connections Images toolbar contains ten available icons for the user to define each as an image bitmap to import into the connection editor screen. This can include schematic internal diagrams of the relays, or other helpful information. Pictures of other test sets may also be used for illustration.

Dynamic Control

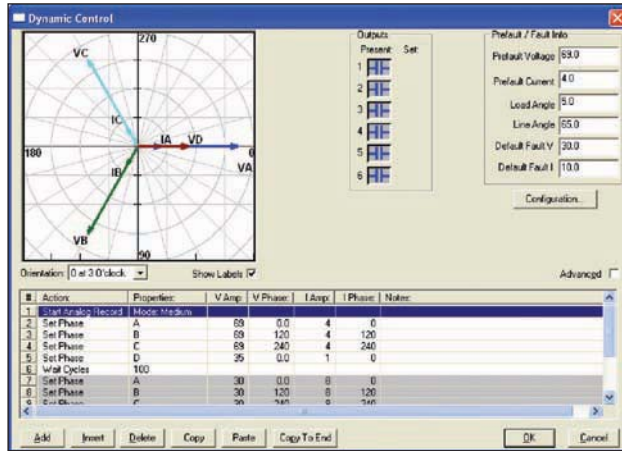

Dynamic Control Screen

The Dynamic Control, accessed from the Test Editor Screen, provides the user an easy means of settings up multi-state dynamic tests that are normally associated with trip and reclosing schemes. The figure above shows an example test setup using the Dynamic Control.

A “state” can be voltage(s), current(s), phase angle(s), timers, start and stop the analog recorder, set Boolean logic for the binary inputs, set binary output(s), or even use variables to set values. The test transitions from one state to another after a programmed time delay of either milliseconds or cycles, or after a trigger condition. In addition, the Dynamic Control allows the user to easily build harmonic waveforms with frequencies up to 1000 Hz. In conjunction with the Dynamic Control the Capture feature may be used to measure and display the output analog waveforms, binary inputs and outputs to evaluate the dynamic test results in a graphic form.

Dynamic Analog Recorder

In association with the Dynamic Control is an analog recorder, which not only records the action of the binary inputs and outputs, but it also records the actual analog waveforms of the outputs. For example, after running a reclosing sequence press OK to view the waveform capture screen. When the Waveform Capture screen comes up, press the Lightning Bolt button. This will load the data from the MPRT resulting in something like the following example.

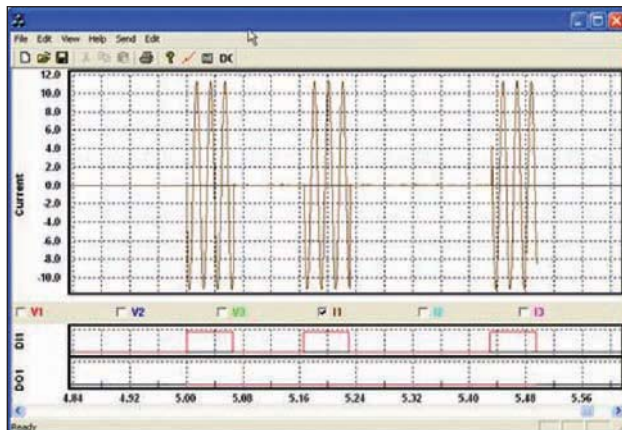

Dynamic Recorder Screen for Single Phase Multi-Shot Reclosing Relay

The user can view the actual outputs waveforms as well as any selected binary inputs and or binary output contacts. This capability also will work with Multi-State or State Sequence Playback. It should also be noted that the user can record the complex waveforms that they applied using the harmonic waveform generator in the dynamic control.

Basic Programming Tool

The Basic Programming Tool provides a means to either import older test macros into AVTS and execute legacy test files, or to send the test system syntax commands to do special test applications not covered by the standard test modules, generic test modules, wizards, DFR playback, vector control, ramp control or dynamic control. These commands can be issued from the Basic Tool icon as part of a special test file.

Modbus Communications

AVTS now has the capability to communicate with relays via the Modbus protocol. This allows the AVTS user the ability to automatically download relay settings from the relay via the Modbus addressing scheme into the AVTS relay setting screen. In addition AVTS can now monitor the relay protection or metering elements via the Modbus communications. This means the user will not need to change the relay outputs, thus test the relay without making any changes to the relay what so ever. Instead of the user having to read the meter values and manually input them into a result screen the software can now read the values automatically. This feature combined with the Sequence Test feature can mean fully automatic testing without user intervention. As an example, the General Electric UR Model G60 relay device settings screen can be seen in the following figure. Note the Modbus address for each setting in the relay is defined in the Device Setting screen. Once the device setting screen is created for the relay, test files may be created.

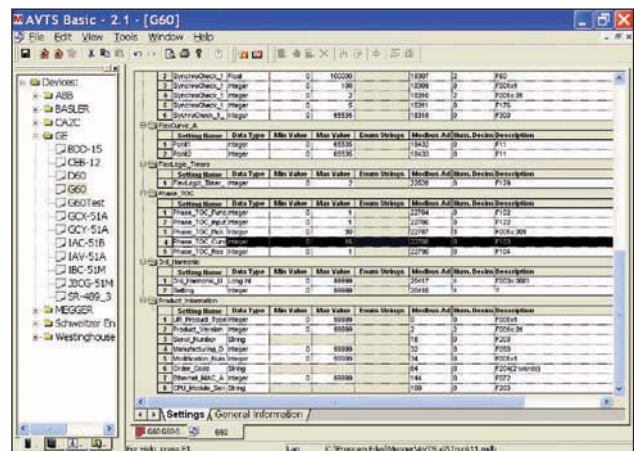

General Electric UR G60 Modbus Device Setting Screen

SS1 File Converter

SS1 files are generated using Power System Simulation software programs by Electrocon® CAPE™ or Aspen One-liner®. By modeling the power system and using the SS1 files, the relay can then be tested dynamically using realistic system test scenarios. The SS1 File Converter will read the SS1 file and create a dynamic state sequence playback file. This file can be used in two ways. The first method of use is as a standard dynamic test. One application is the testing of impedance relays. By modeling the power system using simulation software, the relay can then be tested dynamically using realistic system test scenarios. The dynamic test can be used stand alone or as part of a more complex test module. The other application is as an End-to-End playback file, similar to a DFR playback file.

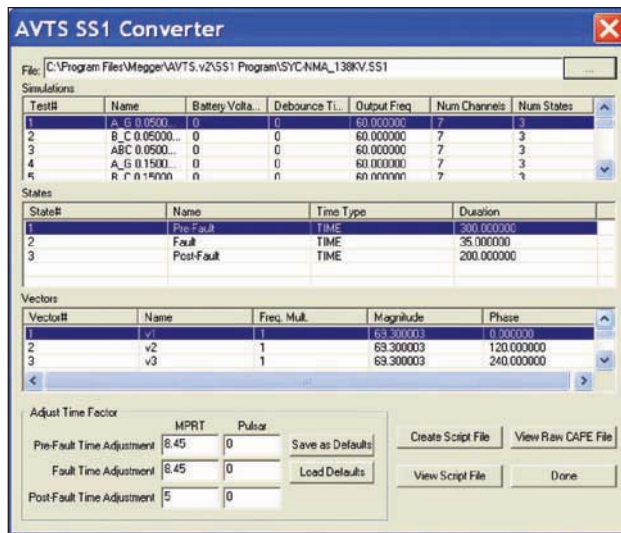

SS1 File Converter

End-to-End Test Capability

End-to-end testing usually involves the coordinated playback of a digital fault recorder (DFR) record by the test equipment. However, there are occasions when a user-defined single or multi-state data playback may be desired. End-to-End tests are run by using a special macro in AVTS Advanced and Professional. The macro will allow the user to select the test file (DFR recording) which is then loaded into the test system. The test system then waits for a GPS trigger pulse to begin playing back the recording. If the user desires to perform a state playback rather than a DFR playback, the user simply constructs a test utilizing the **Data** and **End To End** macros. The Data macro can be edited and allows the user to specify the voltage and current generator states and time durations for playback. A typical End-to-End test setup would look like the following figure.

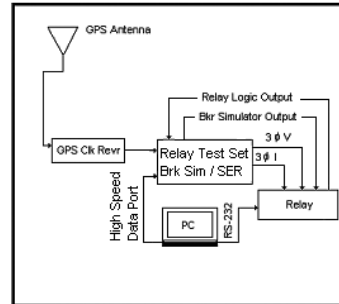

Typical End-to-End Test with MPRT

Import Aspen Relay Database®

In addition, relay settings may also be imported from other databases. For example, relay settings from the Aspen Relay Database® can be seen in the figure below.

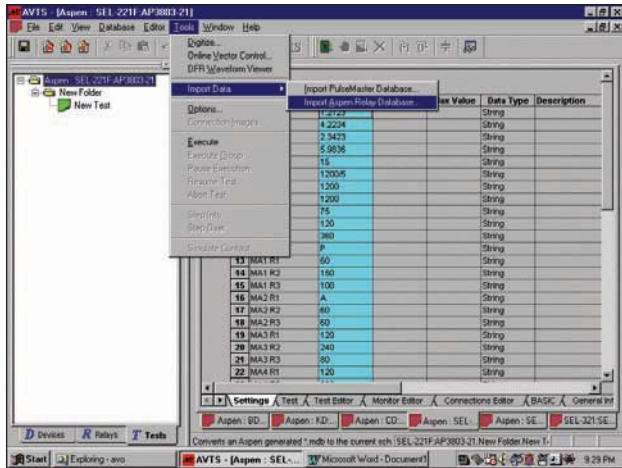

Import Relay Settings From Aspen Database

AVTS PROFESSIONAL VERSION

The Professional version includes all of the features previously described for the Basic and Advanced versions. It also includes special testing and editing tools for playback of Digital Fault Records or EMTP/ATP simulations that are in the IEEE C37.111 COMTRADE format. In addition, it includes the Waveform Digitizer, and the Visual Basic scripts for generating One Touch Test.

Waveform Digitizer

The AVTS Waveform Digitizer Tool enables the user to digitize waveforms and export them to a COMTRADE*.cfg and *.dat files for playback through the Test System. Waveforms from old strip chart recorders, hand drawn waveforms, and waveforms created by oscillographic functions of the modern microprocessor and numerical relays; any waveform that can be represented in a *.bmp format can be digitize. In addition, electromechanical relay analog time curves, that do not fit numerical algorithms, can be scanned into AVTS. The digitizer can be used to create a virtual time curve to be used in the timing test. For example, AVTS software comes with numerous analog curves already digitized and ready for use.

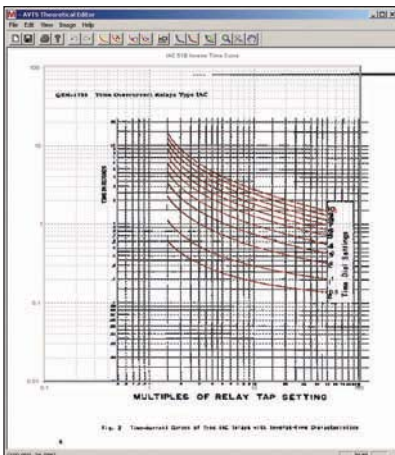

Westinghouse CO-9 Digitized Time-Current Curves

One-Touch Test™

The One-Touch Test utilizes a Visual Basic® Script Control tool that is only available in the Professional version of AVTS 3.1. The script file works with Megger Test Modules that have been specifically created to make use of this feature, see AVTS Test Modules. The Script file allows AVTS software to communicate to a microprocessor-based relay via ASCII text serial communication, and download the relay settings into the AVTS relay Setting Screen automatically. Then, using the Group Execute feature in AVTS, automatically test the relay to the actual relay settings with one touch of the mouse button.

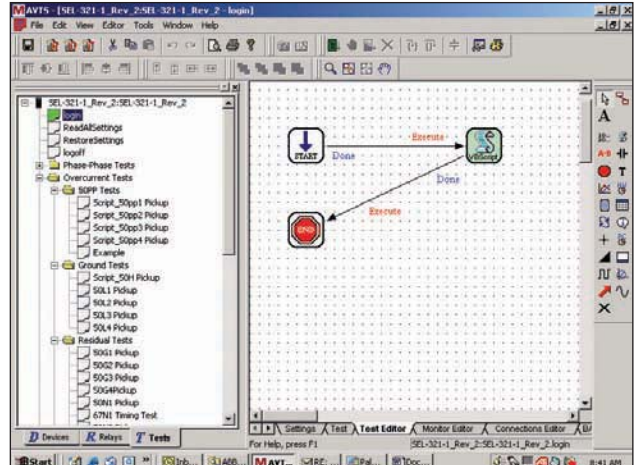

Log-in for SEL-321 Scripted Test Module

DFR Waveform Viewer and Playback

In addition to performing the steady-state testing, it is increasingly becoming a popular practice to perform dynamic and transient testing on protective relays. AVTS DFR Waveform Viewer has the capability of playing back transient waveform data to the Test System waveform generators. In other words, it can recreate a fault (waveforms...) recorded by a Digital Fault Recorder or simulated fault using EMTP/ATP programs. When DFR Waveform Viewer is invoked from the Tools menu, the screen called DfrWaveView dialog box will appear.

From this dialog box a user can convert digital fault recorder data, in COMTRADE format, to hexadecimal files compatible with the Test System waveform generators, select the channels and ranges to be uploaded, and upload and output the waveforms.

In addition, special editing capabilities allow the user to replicate the pre-fault data for as many cycles as desired to insure that the device under test is properly polarized prior to applying the fault. Timing may be started in conjunction with the fault application, thus timing the replay event. Due to the wide operating bandwidth of the test system, there is no degrading of the recorded samples thus high fidelity of the playback waveforms is insured.

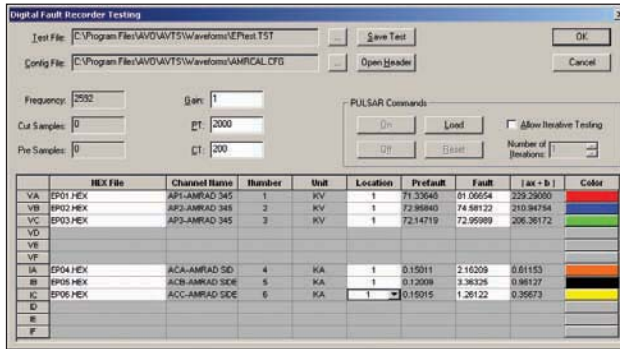

DFR Test Editing Dialog Screen

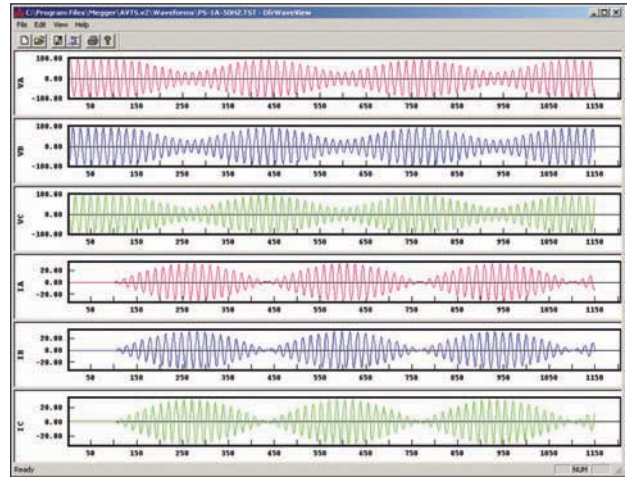

AVTS Professional Waveform Viewer Screen

AVTS TEST MODULES Complex Testing Simplified

Megger has developed a wide variety of relay specific test modules from different relay manufacturers. AVTS Basic Software users can import these test modules, execute, save and print results. Using the Advanced version of AVTS 3.1, users may copy, paste, rename and modify existing test modules to create new relay test modules, which have similar operating characteristics. Contact your local Megger sales office for an up-to-date listing of the available test modules.

Time Saving

Each relay test module is an extremely valuable product for any relay test technician or engineer. It provides the user with a quick, easy way to test a specific relay to the relay manufacturer's specifications, as well as eliminates the time and costs associated with users having to create their own test routines.

One-Touch Test Modules

One-Touch Test modules are currently available for a variety of relays. One-Touch Test requires the AVTS Advanced or Professional version to execute the communication link between AVTS and the relay under test, as well as automatically download relay settings. If you have AVTS Professional, don't forget to ask if the test module you are interested in has the One-Touch Test capability. Test modules, which are One-Touch capable, save the user time, money and removes the possibility of human error when having to read over 100+ relay settings.

ORDERING INFORMATION

STYLE NUMBER IDENTIFICATION

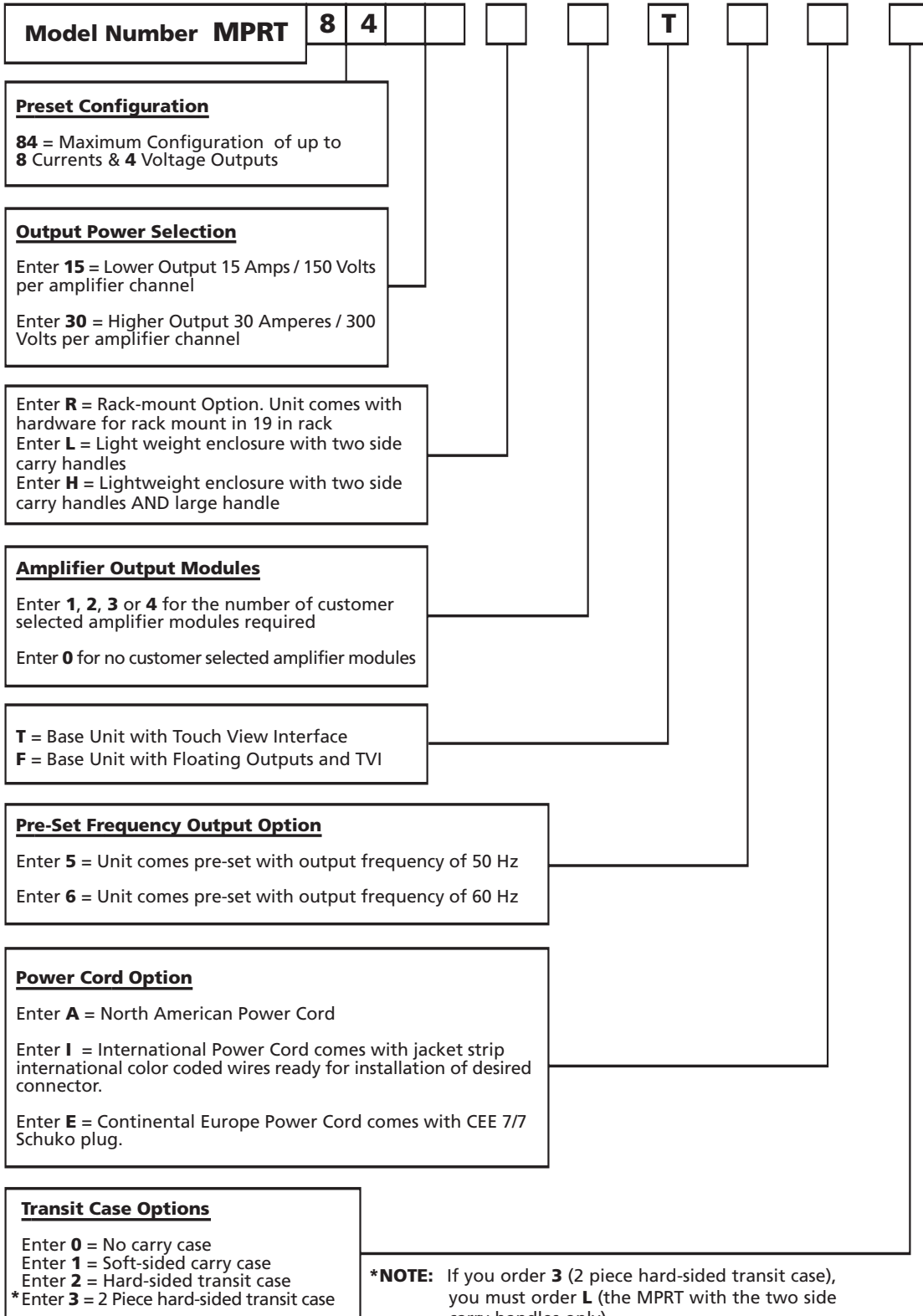

| ORDERING INFORMATION | | | | |
|---|--------------|---|---|--------|
| Item (Qty) | Cat. No. | Item (Qty) | Cat. No. | |
| Popular Configurations | | | | |
| Model 8415, three-phase unit with soft-sided carry case and North American power cord | 8415-L3T6A1 | Model 8415 Voltage/Current Output Module Each output module will come with the following | | |
| Model 8415, three-phase unit with soft-sided carry case and International power cord | 8415-L3T5I1 | | Test lead, red, 200 cm, use with voltage/current outputs and timer (2 ea.)* | 620143 |
| Model 8430, three-phase unit with extra carry handle, soft-sided carry case and North American power cord | 8430-H3T6A1 | | Test lead, black, 200 cm, use with voltage/current outputs and timer (2 ea.)* | 620144 |
| Model 8430, three-phase unit with soft-sided carry case and International power cord | 8430-L3T5I 1 | | Lug adapter, red, 6.2 mm, use with voltage outputs and timer (2 ea.)* | 684002 |
| AVTS, Advanced Version | 544245 | | Lug adapter, black, 6.2 mm, use with voltage outputs and timer (2 ea.)* | 684003 |
| AVTS, Professional Version | 544246 | | Lug adapter, red, 4.1 mm, use with voltage outputs and timer (2 ea.)* | 684004 |
| Included Accessories | | | | |
| Model 8415 and 8430 Base Unit | | | Lug adapter, black, 4.1 mm, use with voltage outputs and timer (2 ea.)* | 684005 |
| Power Cord - Depending on the style number, the unit will come with one of the following: | | | Alligator clip, red, use with voltage outputs and timer (2 ea.)* | 684006 |
| Line cord, North American (1 ea.) | 801046 | | Alligator clip, black, use with voltage outputs and timer (2 ea.)* | 684007 |
| Line cord, Continental Europe with CEE 7/7 Schuko Plug (1 ea.) | 15021 | Model 8430 Voltage/Current Output Module The higher current output module includes 6 mm test leads that are specially made for the higher current of the Model 8430 output module. Each output module will come with the following: | | |
| Line cord, International color coded wire (1 ea.) | 14525 | Test lead, red, 200 cm, use with voltage/current output and timer (2 ea.)* | 620143 | |
| Instruction manual (1 ea.) | 710000 | Test lead, black, 200 cm, use with voltage/current output and timer (2 ea.)* | 620144 | |
| TouchView Interface (1 ea.) | 010004 | Test Lead, Red, 200 cm long, fused 3.15 A (1 ea.) | 568025 | |
| Cable Assembly, Hand-Held Controller (1 ea.) | 620111 | Test Lead, Blue, 200 cm long, fused 500 mA (1 ea.) | 568026 | |
| RS-232 , Straight 9-pin, male/female, Cable Assembly (1 ea.) | 16350 | Test Lead, Black, 200 cm long, 100 k Ohm, 2 Watts (1 ea.) | 500395 | |
| Test lead, black, 200 cm, 100 k ohm in-line resistor | 500395 | Lug adapter, red, 6.2 mm, use with voltage outputs and timer (2 ea.) v | 684002 | |
| Test lead, red, 200 cm, use with Battery Simulator, fused | 568025 | Lug adapter, black, 6.2 mm, use with voltage outputs and timer (2 ea.)* | 684003 | |
| Test lead, blue, 200 cm, use with binary outputs 5 & 6, fused, 500 mA | 568026 | Lug adapter, red, 4.1 mm, use with voltage outputs and timer (2 ea.)* | 684004 | |
| Test lead, red, 200 cm, use with voltage/current outputs and timer (3 ea.)* | 620143 | Lug adapter, black, 4.1 mm, use with voltage outputs and timer (2 ea.)* | 684005 | |
| Test lead, black, 200 cm, use with voltage/current outputs and timer (3 ea.)* | 620144 | Alligator clip, red, use with voltage outputs and timer (1 ea.)* | 684006 | |
| Test Lead, Red, 200 cm long, fused 3.15 A (1 ea.) | 568025 | Alligator clip, black, use with voltage outputs and timer (1 ea.)* | 684007 | |
| Test Lead, Blue, 200 cm long, fused 500 mA (1 ea.) | 568026 | Additional Optional Accessories | | |
| Test Lead, Black, 200 cm long, 100 k Ohm, 2 Watts (1 ea.) | 500395 | Rugged, hard-sided transit case (1ea.) | 684019 | |
| Lug adapter, red, 6.2 mm, use with voltage outputs and timer (3 ea.)* | 684002 | Soft-sided transit case (1 ea.) | 684011 | |
| Lug adapter, black, 6.2 mm, use with voltage outputs and timer (3 ea.)* | 684003 | Two-piece, hardsided, lightweight transit case (L unit only) | 674002 | |
| Lug adapter, red, 4.1 mm, use with voltage outputs and timer (3 ea.)* | 684004 | * Test leads, lugs and clips have a CATIII or better insulation rating | | |
| Lug adapter, black, 4.1 mm, use with voltage outputs and timer (3 ea.)* | 684005 | | | |
| Alligator clip, red, use with voltage outputs and timer (3 ea.)* | 684006 | | | |
| Alligator clip, black, use with voltage outputs and timer (3 ea.)* | 684007 | | | |
| Ethernet Crossover cable (1 ea.) | 620094 | | | |
| Carry Strap (1 ea.) (L Unit only) | 684024 | | | |

MEIU

MPRT EPOCH Interface Unit



DESCRIPTION

The MEIU is a small, light-weight, field portable, interface unit specifically designed to control Multi-Amp EPOCH-II® and EPOCH-20® units with the Megger MPRT relay test system. The combination of the MPRT and the EPOCH-II/20 units provides a very powerful test capability. A single EPOCH-II/20 unit can provide a maximum of 170 Amperes, at 1,000 VA/600 VA, for simulating single phase to ground faults. With a three channel MPRT unit, the MEIU can interface and control up to three EPOCH-II/20 units either manually from the MPRT Touch View Interface or through the AVTS software. With three EPOCH-II/20 units, three-phase fault simulations of up to 170 amperes per phase are possible. The combination of a three channel MPRT, the MEIU and three EPOCH-II/20 units can provide 6 currents for testing three-phase current differential protection schemes.

SPECIFICATIONS

MEIU Input Port:

21 pin D-connector connects the MEIU to the MPRT EPOCH interface connector.

MEIU Output Ports:

Three (3) each 15 pin D-connectors connect the MEIU to the EPOCH -20 units, or the to the EPOCH-II units.

Temperature Range:

Operating: 32 to 122° F Storage: -13 to 158° F
(0 to 50° C) (-25 to 70° C)

Relative Humidity:

90% RH, Non-condensing

Dimensions:

6.0 W x 1.75 H x 6.375 D in.
152.4 W x 44.45 H x 161.9 D mm

Weight:

0.80 lbs. (0.36 kg)

Enclosure

The unit comes mounted in a rugged enclosure for field portability. A padded soft-sided carry case is provided. The following are abbreviated specifications for the EPOCH-II and EPOCH-20 High Current Units. For complete specifications of these units refer to the EPOCH-II or EPOCH-20 bulletins.

ORDERING INFORMATION

| Item (Qty) | Cat No. |
|--------------------------------------|---------|
| MEIU, MPRT EPOCH Interface Unit | 801050 |
| Model MEIU Includes | |
| Instruction Leaflet (1 ea) | 710017 |
| MPRT to MEIU Interface Cable (1 ea.) | 620081 |
| EPOCH-20 Interface Cable (1 ea.) | 15821 |
| EPOCH-II Interface Adapter (1 ea.) | 15833 |
| Carry Case (1 ea.) | 14574 |

MGTR

Megger GPS Timing Reference



DESCRIPTION

The MGTR is a small, light-weight, field portable, GPS satellite receiver system specifically designed to perform End-to-End tests of line protection schemes, with Megger MPRT and Pulsar relay test systems. The MGTR provides a precise Programmed Output Pulse (POP), with 100 nanoseconds of resolution. This output pulse provides a trigger synchronization of two or more MPRT or Pulsar test systems to less than $\pm 1 \mu$ Sec of the Universal Time Coordinated (UTC).

The unit comes with a 50 foot (15.2 m) long cable and all-weather, high-performance, high noise immunity antenna with an integrated low-noise preamplifier. Control of the MGTR is through a standard RS-232 serial connection and an adapter cable with a 9-pin D-sub connect. Software is provided to communicate to, and control, the MGTR unit.

SPECIFICATIONS

Input Power

AC/DC Adapter
105 to 130 Volts AC, 1 ϕ , 55 - 65 Hz/24 VDC, 400mA

Long-Term Stability

1 x 10⁻¹² after 24 hours tracking

Accuracy While Coasting

1 x 10⁻¹⁰ per day after 3 days of locked operation

Time to First Fix (typical)

Hot Start: <30 seconds (with valid almanac, time, date, position & ephemeris) Cold Start: <3 minutes typical

Programmable Output Pulse

Drive: TTL into 50 Ω
Rise/Fall Time: 10 ns Maximum
Pulse Width: Programmable from 1 μ s – 250 ms
Polarity: Selectable, positive/negative
Resolution: 100 ns
Accuracy: 100 ns RMS

External Event Input

TTL/CMOS level,
edge-triggered, polarity selectable
Resolution: 100 ns
Accuracy: 100 ns RMS

MUX 1 Output

The output is user selectable. Outputs available are;
1, 10, 100 kHz, 1, 5, 10 MHz, 1 PPS
Drive: TTL into 50 Ω
Rise/Fall Time: 10 ns Maximum

1 PPS Output

(Referenced to UTC)
Drive: TTL into 50 Ω
Rise Time: 10 ns Maximum
Pulse Width: Positive pulse, 1 ms nominal, rising edge on-time.
Accuracy: 100 ns RMS

10 MHz Output

Standard frequency output 10 MHz. High spectral purity sinewave, +10 dBm into 50 Ω , ± 2 dB

Temperature Range (MGTR)

Operating: 14 to 158 $^{\circ}$ F (-20 to 70 $^{\circ}$ C)
Storage: -6 to 185 $^{\circ}$ F (-40 to 85 $^{\circ}$ C)

Relative Humidity (MGTR)

95% RH, Non-condensing

Dimensions

MGTR Unit Enclosure
4.125 W x 1.5 H x 4.0 D in.
104.8 W x 38.1 H x 101.6 D mm

MGTR Unit Weight

1.0 lbs. (0.453 kg)

Safety

IEC 61010-1, Amendments 1 and 2

Enclosure

The unit comes mounted in a rugged enclosure for field portability. An optional padded soft-sided carry case is available. The soft-sided carry case protects the unit from light rain and dust. The soft case also has pockets to hold the antenna, cables and AC/DC power supply.

ORDERING INFORMATION

| Item (Qty) | Cat. No. |
|--|----------|
| Megger GPS Timing Reference unit | MGTR |
| MGTR Includes | |
| Instruction Manual (1 ea) | 750018 |
| MGTR Receiver Unit, with Software CD (1 ea.) | 569010 |
| Control Cable Assy. (1 ea.) | 620082 |
| GPS Antenna Kit (1 ea.) | 801055 |
| Antenna Kit contains the following: | |
| GPS Antenna (1 ea.) | 650016 |
| 50 ft. cable (1 ea.) | 620083 |
| 4 inch SS Antenna Mount (1 ea.) | 650017 |
| AC/DC Power Adapter (1 ea.) | 561024 |
| Optional Accessories | |
| Soft-sided transit case (1 ea.) | MC6674 |

UK

Archcliffe Road Dover
CT17 9EN England
T +44 (0) 1304 502101
F +44 (0) 1304 207342
UKsales@megger.com

UNITED STATES

4271 Bronze Way
Dallas TX 75237-1019 USA
T 800 723 2861 (USA only)
T +1 214 333 3201
F +1 214 331 7399
USsales@megger.com

OTHER TECHNICAL SALES OFFICES

Täby SWEDEN, Norristown USA,
Sydney AUSTRALIA,
Toronto CANADA, Trappes FRANCE,
Kingdom of BAHRAIN, Mumbai INDIA
Johannesburg SOUTH AFRICA
Chonburi THAILAND

ISO STATEMENT

Registered to ISO 9001:2000 Cert. no. 10006.02

MPRT_AVTS3.1_DS_en_V28

www.megger.com
Megger is a registered trademark